

NTP4302, NTB4302

Power MOSFET 74 Amps, 30 Volts

N-Channel TO-220 & D²PAK



ON Semiconductor®

<http://onsemi.com>

Features

- Low $R_{DS(on)}$
- Higher Efficiency Extending Battery Life
- Diode Exhibits High Speed, Soft Recovery
- Avalanche Energy Specified
- I_{DSS} Specified at Elevated Temperature
- Pb-Free Packages are Available

Typical Applications

- DC-DC Converters
- Low Voltage Motor Control
- Power Management in Portable and Battery Powered Products:
Ie: Computers, Printers, Cellular and Cordless Telephones, and PCMCIA Cards

MAXIMUM RATINGS ($T_J = 25^\circ\text{C}$ unless otherwise noted)

| Rating | Symbol | Value | Unit |
|--|------------------------------------|----------------|--------------------------|
| Drain-to-Source Voltage | V_{DSS} | 30 | Vdc |
| Drain-to-Gate Voltage ($R_{GS} = 10\text{ M}\Omega$) | V_{DGR} | 30 | Vdc |
| Gate-to-Source Voltage – Continuous | V_{GS} | ± 20 | Vdc |
| Drain Current | I_D | 74 | Adc |
| – Continuous @ $T_C = 25^\circ\text{C}$ | I_D | 47 | |
| – Continuous @ $T_C = 100^\circ\text{C}$ | I_{DM} | 175 | Apk |
| – Single Pulse ($t_p \leq 10\ \mu\text{s}$) | | | |
| Total Power Dissipation @ $T_C = 25^\circ\text{C}$ Derate above 25°C | P_D | 80 0.66 | W W/ $^\circ\text{C}$ |
| Operating and Storage Temperature Range | T_J, T_{stg} | -55 to +150 | $^\circ\text{C}$ |
| Single Pulse Drain-to-Source Avalanche Energy – Starting $T_J = 25^\circ\text{C}$ ($V_{DD} = 30\text{ Vdc}$, $V_{GS} = 10\text{ Vdc}$, $L = 5.0\text{ mH}$ $I_{L(pk)} = 17\text{ A}$, $V_{DS} = 30\text{ Vdc}$, $R_G = 25\ \Omega$) | E_{AS} | 722 | mJ |
| Thermal Resistance | $R_{\theta JC}$ $R_{\theta JA}$ | 1.55 70 | $^\circ\text{C/W}$ |
| – Junction-to-Case | | | |
| – Junction-to-Ambient (Note 1) | | | |
| Maximum Lead Temperature for Soldering Purposes, 1/8 in from case for 10 seconds | T_L | 260 | $^\circ\text{C}$ |

Maximum ratings are those values beyond which device damage can occur. Maximum ratings applied to the device are individual stress limit values (not normal operating conditions) and are not valid simultaneously. If these limits are exceeded, device functional operation is not implied, damage may occur and reliability may be affected.

1. When surface mounted to an FR4 Board using minimum recommended Pad Size, (Cu Area 0.412 in²).
2. Current limited by internal lead wires.

| V_{DSS} | $R_{DS(ON)}\text{ MAX}$ | $I_D\text{ MAX}$ |
|-----------|-------------------------|------------------|
| 30 V | 9.3 m Ω @ 10 V | 74 A |

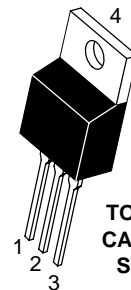
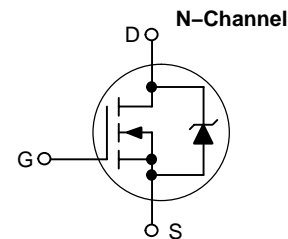

TO-220AB
CASE 221A
STYLE 5



D²PAK
CASE 418AA
STYLE 2

MARKING DIAGRAMS & PIN ASSIGNMENTS

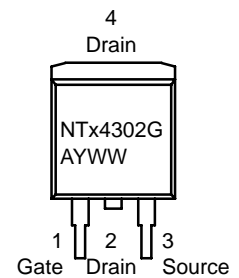
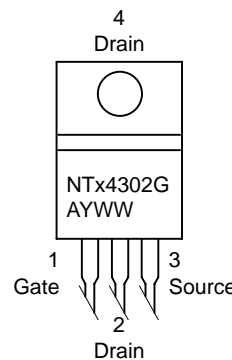

NTx4302 = Device Code
x = B or P
A = Assembly Location
Y = Year
WW = Work Week
G = Pb-Free Package

ORDERING INFORMATION

See detailed ordering and shipping information in the package dimensions section on page 5 of this data sheet.

NTP4302, NTB4302

ELECTRICAL CHARACTERISTICS (T_J = 25°C unless otherwise noted)

| Characteristic | Symbol | Min | Typ | Max | Unit |
|----------------|--------|-----|-----|-----|------|
|----------------|--------|-----|-----|-----|------|

OFF CHARACTERISTICS

| | | | | | |
|---|----------------------|---------|---------|-----------|--------------|
| Drain-to-Source Breakdown Voltage (Note 3) (V _{GS} = 0 Vdc, I _D = 250 μAdc) Temperature Coefficient (Positive) | V _{(BR)DSS} | 30 – | – 25 | – – | Vdc mV/°C |
| Zero Gate Voltage Drain Current (V _{DS} = 30 Vdc, V _{GS} = 0 Vdc) (V _{DS} = 30 Vdc, V _{GS} = 0 Vdc, T _J = 125°C) | I _{DSS} | – – | – – | 1.0 10 | μAdc |
| Gate-Body Leakage Current (V _{GS} = ±20 Vdc, V _{DS} = 0 Vdc) | I _{GSS} | – | – | ±100 | nAdc |

ON CHARACTERISTICS (Note 3)

| | | | | | |
|---|---------------------|----------|-------------------|--------------------|--------------|
| Gate Threshold Voltage (Note 3) (V _{DS} = V _{GS} , I _D = 250 μAdc) Threshold Temperature Coefficient (Negative) | V _{GS(th)} | 1.0 – | 1.9 –3.8 | 3.0 – | Vdc mV/°C |
| Static Drain-to-Source On-Resistance (Note 3) (V _{GS} = 10 Vdc, I _D = 37 Adc) (V _{GS} = 10 Vdc, I _D = 20 Adc) (V _{GS} = 4.5 Vdc, I _D = 10 Adc) | R _{DS(on)} | – | 6.8 6.8 9.5 | 9.3 9.3 12.5 | mΩ |
| Forward Transconductance (Note 3) (V _{DS} = 10 Vdc, I _D = 20 Adc) | g _{FS} | – | 40 | – | mhos |

DYNAMIC CHARACTERISTICS

| | | | | | | |
|----------------------|---|------------------|---|------|------|----|
| Input Capacitance | (V _{DS} = 24 Vdc, V _{GS} = 0 Vdc, f = 1.0 MHz) | C _{iss} | – | 2050 | 2400 | pF |
| Output Capacitance | | C _{oss} | – | 640 | 800 | |
| Transfer Capacitance | | C _{rss} | – | 225 | 310 | |

SWITCHING CHARACTERISTICS (Note 4)

| | | | | | | |
|---------------------|--|---------------------|---|-----|----|----|
| Turn-On Delay Time | (V _{DD} = 24 Vdc, I _D = 20 Adc, V _{GS} = 10 Vdc, R _G = 2.5 Ω) (Note 3) | t _{d(on)} | – | 10 | 18 | ns |
| Rise Time | | t _r | – | 22 | 35 | |
| Turn-Off Delay Time | | t _{d(off)} | – | 45 | 75 | |
| Fall Time | | t _f | – | 35 | 70 | |
| Turn-On Delay Time | (V _{DD} = 24 Vdc, I _D = 10 Adc, V _{GS} = 4.5 Vdc, R _G = 2.5 Ω) (Note 3) | t _{d(on)} | – | 18 | – | ns |
| Rise Time | | t _r | – | 70 | – | |
| Turn-Off Delay Time | | t _{d(off)} | – | 32 | – | |
| Fall Time | | t _f | – | 30 | – | |
| Gate Charge | (V _{DS} = 24 Vdc, I _D = 37 Adc, V _{GS} = 4.5 Vdc) (Note 3) | Q _T | – | 28 | – | nC |
| | | Q _{gs} | – | 7.5 | – | |
| | | Q _{gd} | – | 19 | – | |

SOURCE-DRAIN DIODE CHARACTERISTICS

| | | | | | | |
|--------------------------------|---|-----------------|--------|--------------|----------|-----|
| Forward On-Voltage | (I _S = 20 Adc, V _{GS} = 0 Vdc) (Note 3) (I _S = 20 Adc, V _{GS} = 0 Vdc, T _J = 125°C) | V _{SD} | – – | 0.90 0.75 | 1.3 – | Vdc |
| Reverse Recovery Time | (I _S = 20 Adc, V _{GS} = 0 Vdc, di _S /dt = 100 A/μs) (Note 3) | t _{rr} | – | 37 | – | ns |
| | | t _a | – | 21 | – | |
| | | t _b | – | 16 | – | |
| Reverse Recovery Stored Charge | | Q _{RR} | – | 0.035 | – | μC |

3. Pulse Test: Pulse Width ≤ 300 μs, Duty Cycle ≤ 2%.
4. Switching characteristics are independent of operating junction temperatures.

NTP4302, NTB4302

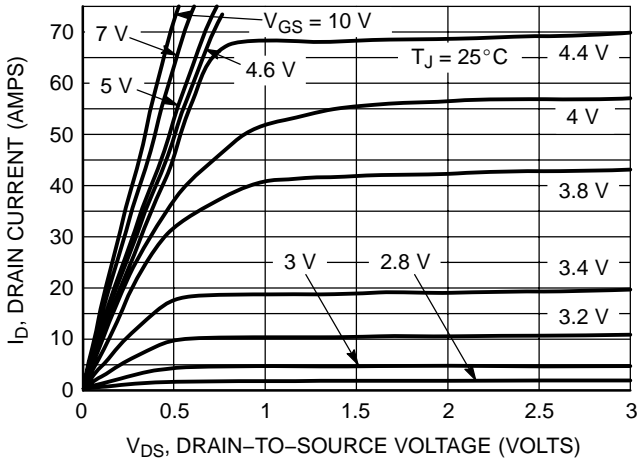

Figure 1. On-Region Characteristics

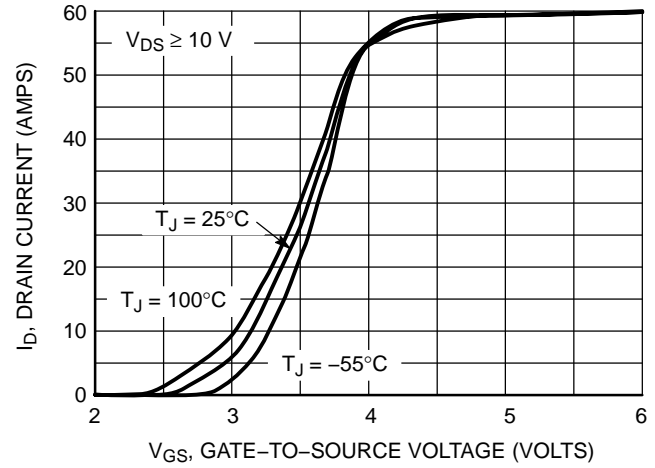

Figure 2. Transfer Characteristics

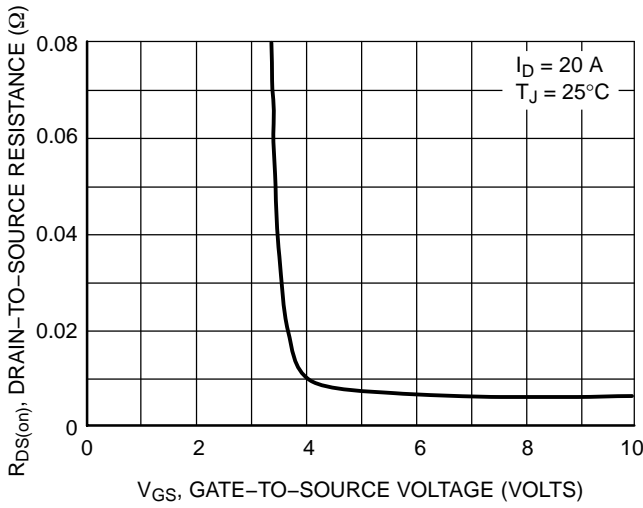

Figure 3. On-Resistance versus Gate-to-Source Voltage

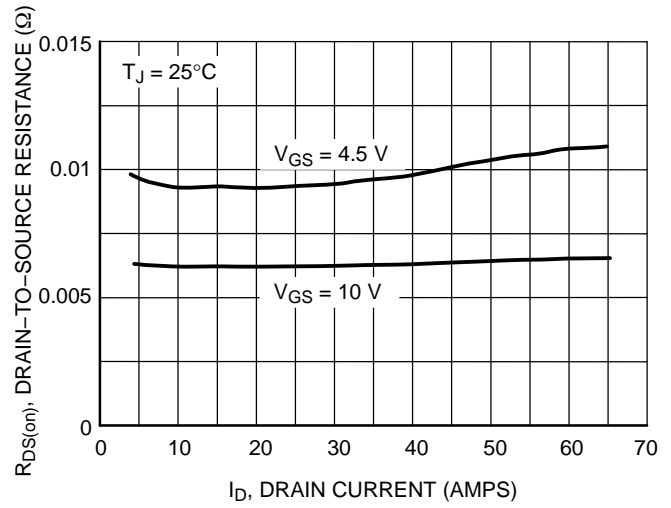

Figure 4. On-Resistance versus Drain Current and Gate Voltage

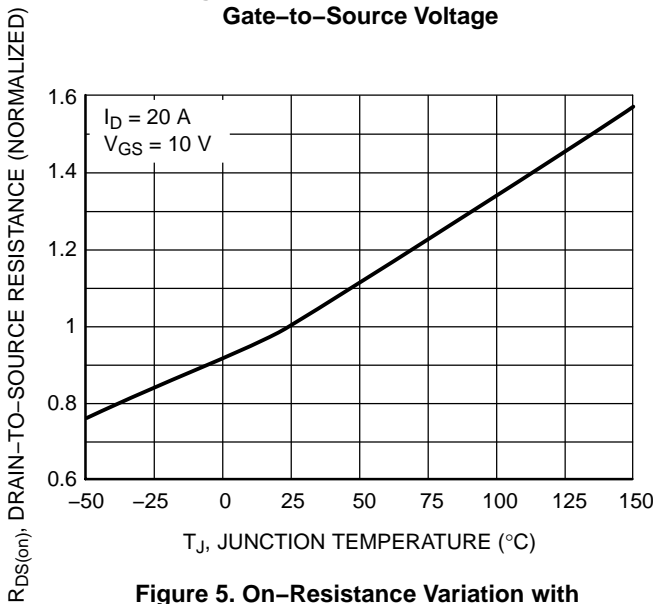

Figure 5. On-Resistance Variation with Temperature

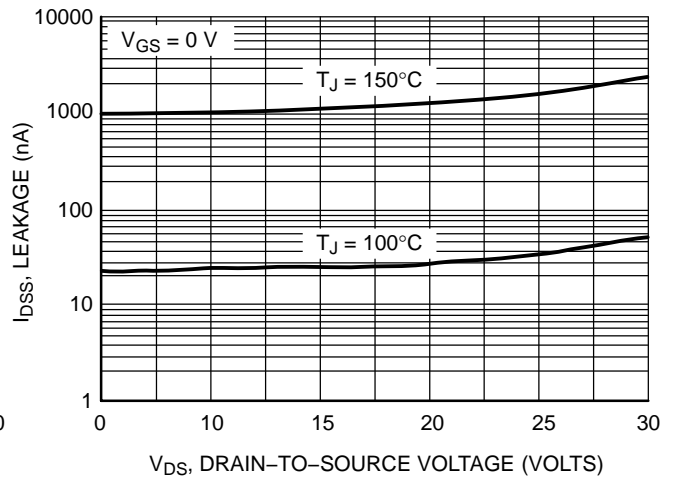

Figure 6. Drain-to-Source Leakage Current versus Voltage

NTP4302, NTB4302

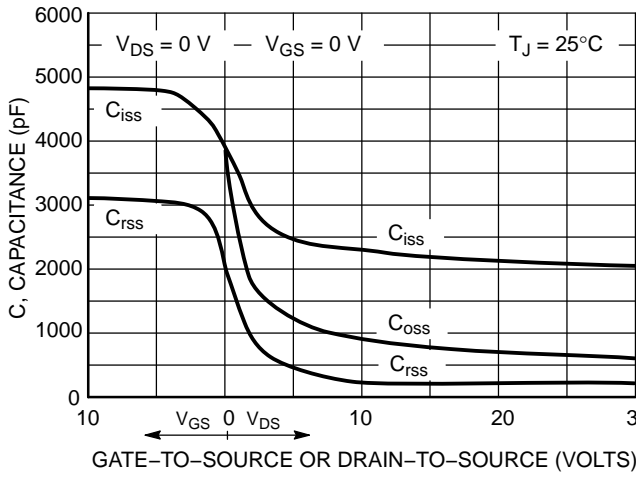

Figure 7. Capacitance Variation

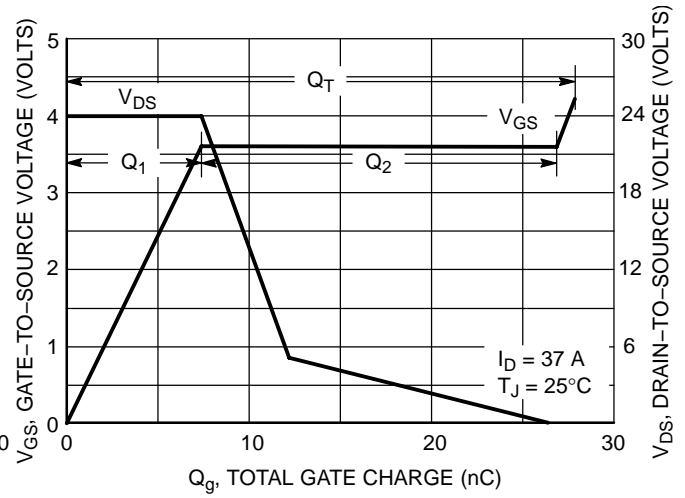

Figure 8. Gate-to-Source and Drain-to-Source Voltage versus Total Charge

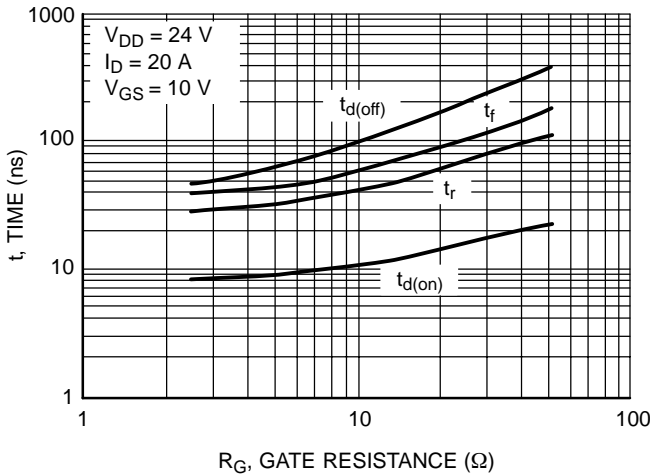

Figure 9. Resistive Switching Time Variations versus Gate Resistance

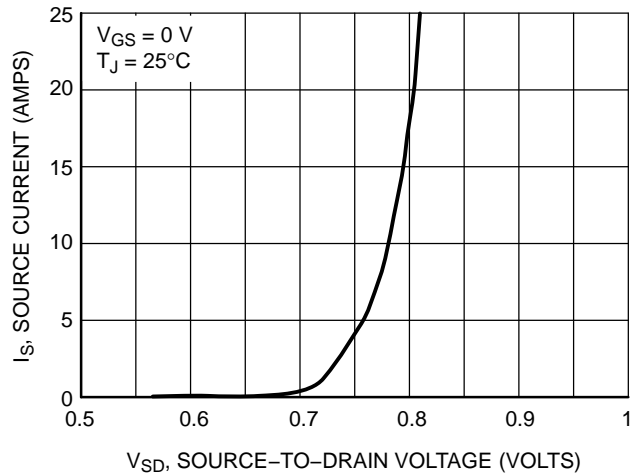

Figure 10. Diode Forward Voltage versus Current

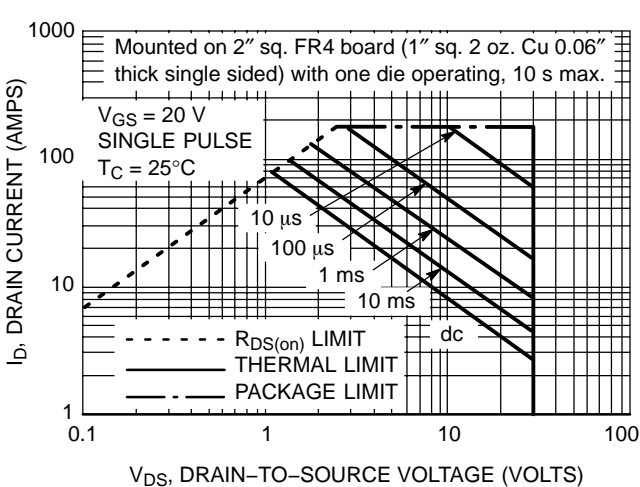

Figure 11. Maximum Rated Forward Biased Safe Operating Area

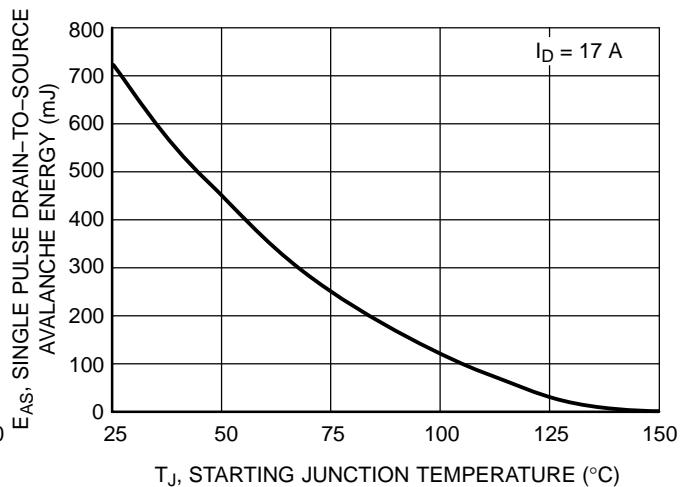

Figure 12. Maximum Avalanche Energy versus Starting Junction Temperature

NTP4302, NTB4302

SAFE OPERATING AREA

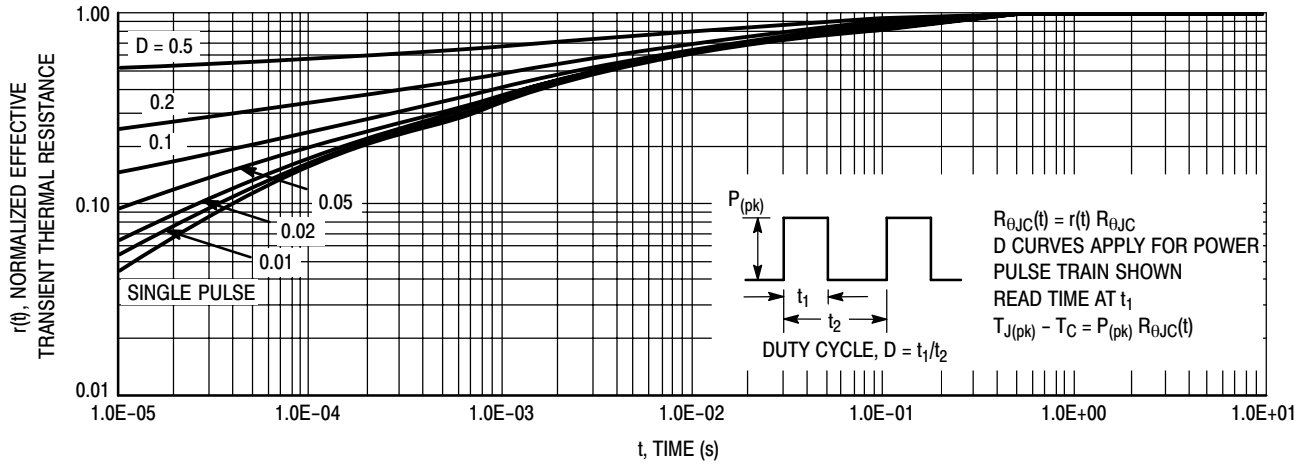

Figure 13. Thermal Response

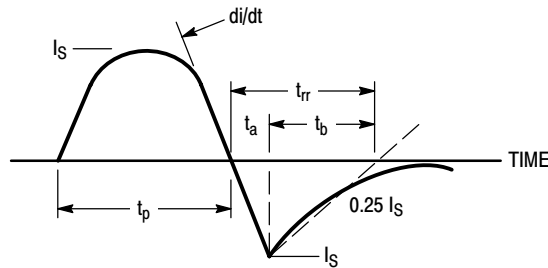

Figure 14. Diode Reverse Recovery Waveform

ORDERING INFORMATION

| Device | Package | Shipping [†] |
|------------|---------------------------------|-----------------------|
| NTP4302 | TO-220AB | 50 Units / Rail |
| NTP4302G | TO-220AB (Pb-Free) | 50 Units / Rail |
| NTB4302 | D ² PAK | 50 Units / Rail |
| NTB4302G | D ² PAK (Pb-Free) | 50 Units / Rail |
| NTB4302T4 | D ² PAK | 800 / Tape & Reel |
| NTB4302T4G | D ² PAK (Pb-Free) | 800 / Tape & Reel |

[†]For information on tape and reel specifications, including part orientation and tape sizes, please refer to our Tape and Reel Packaging Specifications Brochure, BRD8011/D.

NTP4302, NTB4302

PACKAGE DIMENSIONS

D²PAK
CASE 418AA-01
ISSUE O

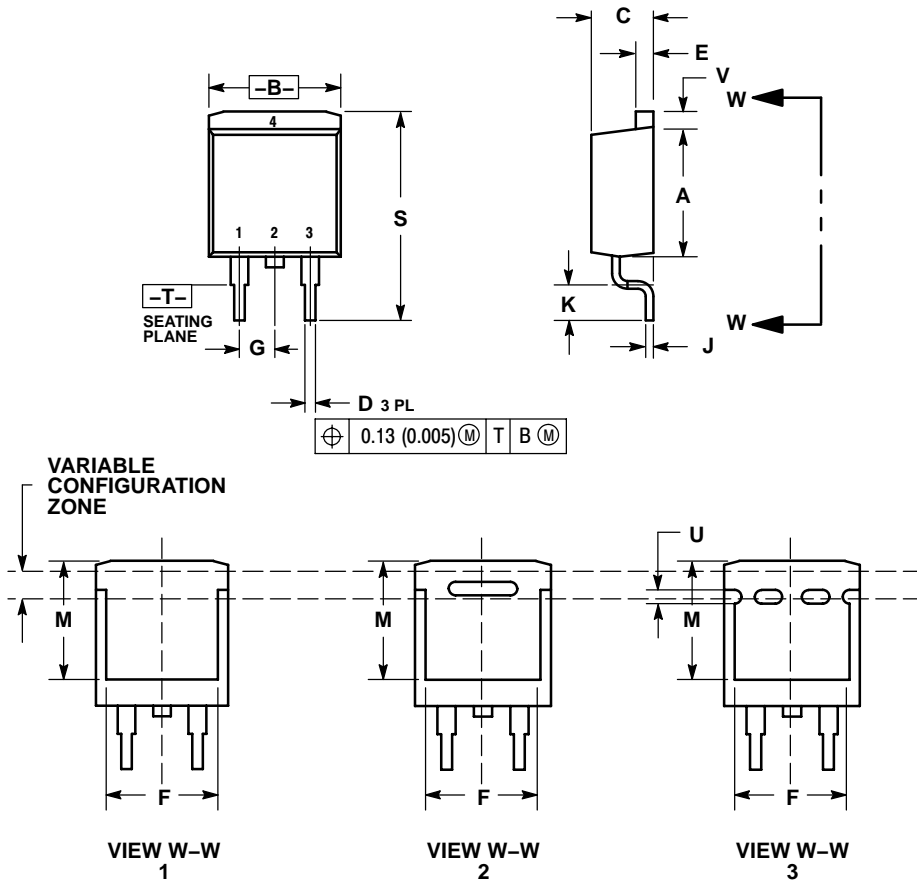

- NOTES:
1. DIMENSIONING AND TOLERANCING PER ANSI Y14.5M, 1982.
2. CONTROLLING DIMENSION: INCH.

| DIM | INCHES | | MILLIMETERS | |
|-----|-----------|-------|-------------|-------|
| | MIN | MAX | MIN | MAX |
| A | 0.340 | 0.380 | 8.64 | 9.65 |
| B | 0.380 | 0.405 | 9.65 | 10.29 |
| C | 0.160 | 0.190 | 4.06 | 4.83 |
| D | 0.020 | 0.036 | 0.51 | 0.92 |
| E | 0.045 | 0.055 | 1.14 | 1.40 |
| F | 0.310 | --- | 7.87 | --- |
| G | 0.100 BSC | --- | 2.54 BSC | --- |
| J | 0.018 | 0.025 | 0.46 | 0.64 |
| K | 0.090 | 0.110 | 2.29 | 2.79 |
| M | 0.280 | --- | 7.11 | --- |
| S | 0.575 | 0.625 | 14.60 | 15.88 |
| V | 0.045 | 0.055 | 1.14 | 1.40 |

- STYLE 2:
PIN 1. GATE
2. DRAIN
3. SOURCE
4. DRAIN

SOLDERING FOOTPRINT*

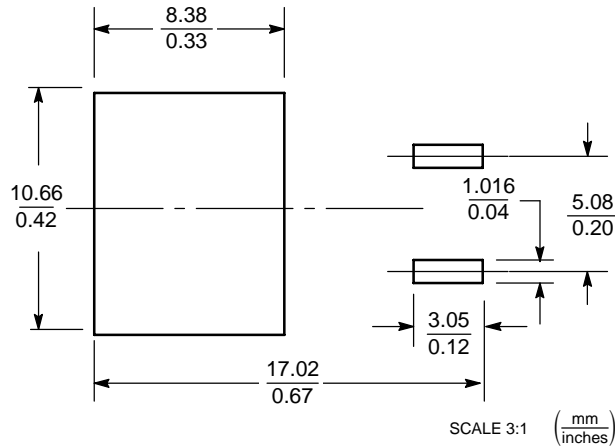

*For additional information on our Pb-Free strategy and soldering details, please download the ON Semiconductor Soldering and Mounting Techniques Reference Manual, SOLDERRM/D.

NTP4302, NTB4302

PACKAGE DIMENSIONS

TO-220
CASE 221A-09
ISSUE AA

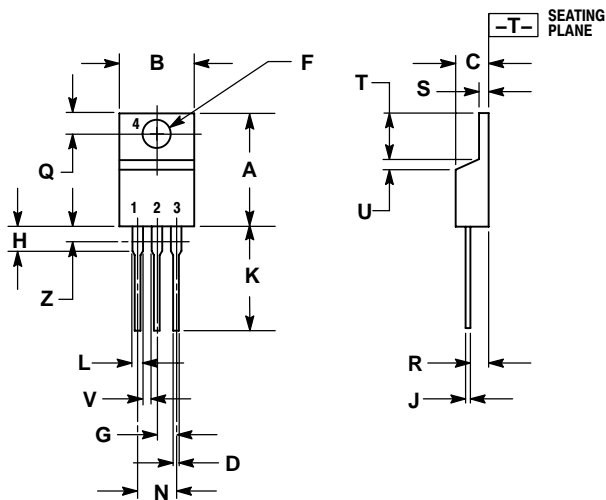

NOTES:

1. DIMENSIONING AND TOLERANCING PER ANSI Y14.5M, 1982.
2. CONTROLLING DIMENSION: INCH.
3. DIMENSION Z DEFINES A ZONE WHERE ALL BODY AND LEAD IRREGULARITIES ARE ALLOWED.

| DIM | INCHES | | MILLIMETERS | |
|-----|--------|-------|-------------|-------|
| | MIN | MAX | MIN | MAX |
| A | 0.570 | 0.620 | 14.48 | 15.75 |
| B | 0.380 | 0.405 | 9.66 | 10.28 |
| C | 0.160 | 0.190 | 4.07 | 4.82 |
| D | 0.025 | 0.035 | 0.64 | 0.88 |
| F | 0.142 | 0.147 | 3.61 | 3.73 |
| G | 0.095 | 0.105 | 2.42 | 2.66 |
| H | 0.110 | 0.155 | 2.80 | 3.93 |
| J | 0.018 | 0.025 | 0.46 | 0.64 |
| K | 0.500 | 0.562 | 12.70 | 14.27 |
| L | 0.045 | 0.060 | 1.15 | 1.52 |
| N | 0.190 | 0.210 | 4.83 | 5.33 |
| Q | 0.100 | 0.120 | 2.54 | 3.04 |
| R | 0.080 | 0.110 | 2.04 | 2.79 |
| S | 0.045 | 0.055 | 1.15 | 1.39 |
| T | 0.235 | 0.255 | 5.97 | 6.47 |
| U | 0.000 | 0.050 | 0.00 | 1.27 |
| V | 0.045 | --- | 1.15 | --- |
| Z | --- | 0.080 | --- | 2.04 |

STYLE 5:

- PIN 1. GATE
2. DRAIN
3. SOURCE
4. DRAIN

ON Semiconductor and **ON** are registered trademarks of Semiconductor Components Industries, LLC (SCILLC). SCILLC reserves the right to make changes without further notice to any products herein. SCILLC makes no warranty, representation or guarantee regarding the suitability of its products for any particular purpose, nor does SCILLC assume any liability arising out of the application or use of any product or circuit, and specifically disclaims any and all liability, including without limitation special, consequential or incidental damages. "Typical" parameters which may be provided in SCILLC data sheets and/or specifications can and do vary in different applications and actual performance may vary over time. All operating parameters, including "Typicals" must be validated for each customer application by customer's technical experts. SCILLC does not convey any license under its patent rights nor the rights of others. SCILLC products are not designed, intended, or authorized for use as components in systems intended for surgical implant into the body, or other applications intended to support or sustain life, or for any other application in which the failure of the SCILLC product could create a situation where personal injury or death may occur. Should Buyer purchase or use SCILLC products for any such unintended or unauthorized application, Buyer shall indemnify and hold SCILLC and its officers, employees, subsidiaries, affiliates, and distributors harmless against all claims, costs, damages, and expenses, and reasonable attorney fees arising out of, directly or indirectly, any claim of personal injury or death associated with such unintended or unauthorized use, even if such claim alleges that SCILLC was negligent regarding the design or manufacture of the part. SCILLC is an Equal Opportunity/Affirmative Action Employer. This literature is subject to all applicable copyright laws and is not for resale in any manner.

PUBLICATION ORDERING INFORMATION

LITERATURE FULFILLMENT:

Literature Distribution Center for ON Semiconductor
P.O. Box 61312, Phoenix, Arizona 85082-1312 USA
Phone: 480-829-7710 or 800-344-3860 Toll Free USA/Canada
Fax: 480-829-7709 or 800-344-3867 Toll Free USA/Canada
Email: orderlit@onsemi.com

N. American Technical Support: 800-282-9855 Toll Free USA/Canada

Japan: ON Semiconductor, Japan Customer Focus Center
2-9-1 Kamimeguro, Meguro-ku, Tokyo, Japan 153-0051
Phone: 81-3-5773-3850

ON Semiconductor Website: <http://onsemi.com>

Order Literature: <http://www.onsemi.com/litorder>

For additional information, please contact your local Sales Representative.